

Stationary concrete pump

BSA 1407 D4

Output up to 71 m³/h
Delivery pressure up to 106 bar

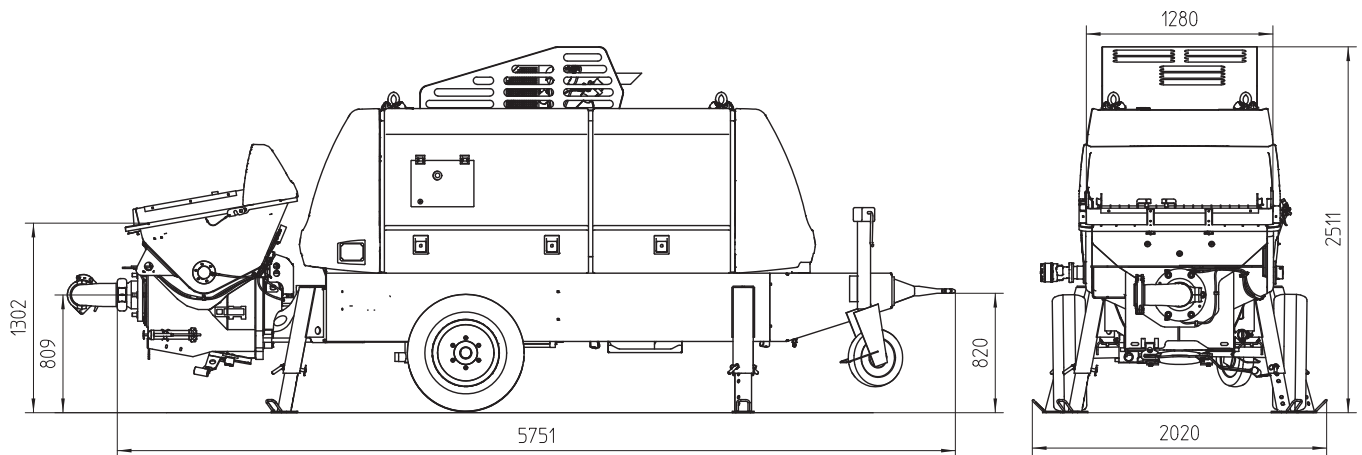

Note: Standard version. Dimensions and weights depend on equipment. Subject to technical modifications and errors.

Technical data

Model		BSA 1407 D4
Material number		102408.000
Output	m ³ /h	71 / 47 *
Delivery pressure	bar	71 / 106 *
Delivery cylinder	Ø mm	200
Delivery cyl. stroke	mm	1400
Strokes / minute		27 / 18 *
Engine power	kW	105
Hopper		RS 909
Capacity	l	ca. 600
Filling height	m	1.3
Transfer tube		S 2015 D
Line connection	mm	SK 125
Pressure connection	"	5.5
Control system		SPC-OPS
Weight	kg	4500

* Values for hydraulic fluid being fed to piston-side
All data maximum theoretical

Serial equipment

Agitator safety switch off	Operating manuals (1 × paper, 1 × CD-ROM) spare part list
Cable remote control 10 m	Outriggers 4 × mech.
Central lubrication on hopper with hand lever press	Reduction bend 90°; SK 150 → SK 125
Cleaning accessories	Speed drawdown automatically on pump stop
Coloring: Pump, frame, roof, tank and hood anthracite-grey Cover chrome yellow	Splash guard
Concrete hopper with agitator	Support wheel
Coupling ring (DIN)	Tool set incl. standard equipment
Drive diesel, Deutz 105 kW, Stage 4	Trailer F8, travelling in site
Electronic error management	
Ergonic Graphic Display (EGD)	
Flushing water pump 50 l/min 20 bar	
Gate valve connection	
Grill 70 mm	

See quotation for exact serial delivery scope.
Comprehensive range of options available on request.