



Putzmeister



Economic system solutions

Conveying, mixing, transportation – from one source

Applications

Products

Inorganic materials



Organic materials



Mining / Backfilling 5

Backfilling / tunnel linings / upward conveyance of sludge



Coal fuelled power stations 7

Fly ash / bottom ash disposal



Sludge removal 8

Sludge removal and transport



Tunnel construction 10

Conveyance of excavation residues / annular space backfilling for tubbing



Oil & Gas industries 12

Conveyance of material with minimal liquid content



Biomass power plants 15

Conveyance of biomass / pasty material with large grain size



Sewage treatment plants 18

Sewage sludge disposal



Co-Incineration 20

Conveyance of sewage sludge and household waste



Coal fuelled power stations 22

Conveyance of feed fuel / coal sludge



Cement industry 23

Conveyance of alternative fuels



Hazardous waste treatment 25

Conveyance of hazardous waste

Piston pump with S-transfer tube KOS 27

Piston pump with seat-valves HSP 28

Piston pump with ball valves KOV 29

Single-piston pump EKO 30

Power pack units 31

Silos 32

Sliding frames 33

Discharge augers 33

System components 34

Range of services 38

Pump technology



Silo technology



Accessories

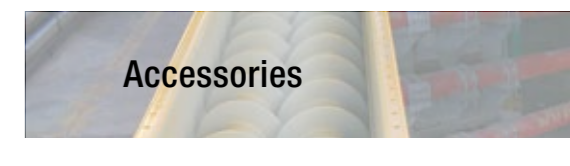

Service

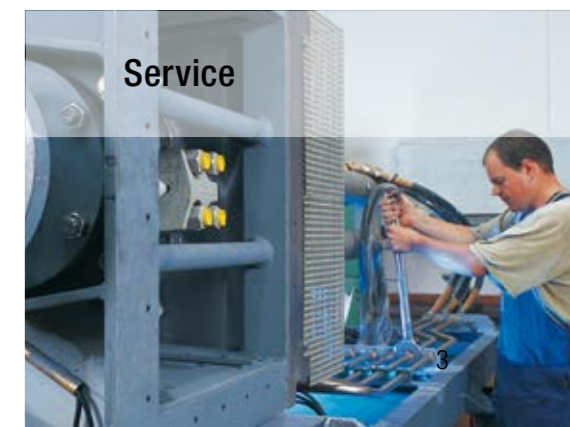



Safe „backfilling“

High production costs, safety concerns, environmental aspects and so on are forcing mine operators to undertake extensive restructuring. Backfilling of residues from mines and power stations plays an important role. The core components of such installations are S-transfer tube pumps (KOS), seat valve pumps (HSP) and ZX piping systems from Putzmeister:

- Conveying distances up to 11 km from the mixing facility located on the surface to the backfill location underground and with no pumps installed on route
- Up to 400 m³/h conveying capacities
- Up to 150 bar operating pressure
- Suitable for abrasive material

Advantages of the system

- Closed loop of washery tailings: minepit – treatment – minepit
- High operational safety and reliability
- Increased stability of the mining structures
- Low wear costs
- Better exploitation of deposits
- Lower specific energy consumption
- Safe and clean transport in pipelines
- Reduced water circulating in pipelines



Creating tunnel linings

for targeted mine ventilation with the BSM 1002 (Elefantino)
 Mining companies are constantly searching for ways to ensure that working underground is economical and safe. This is particularly true of coal mining companies. With the BSM 1002, it is possible to mix and pump building materials on site, e.g. concrete or other mineral substances mixed with cement. These materials are for example best suited for building tunnel linings in a coal mine.

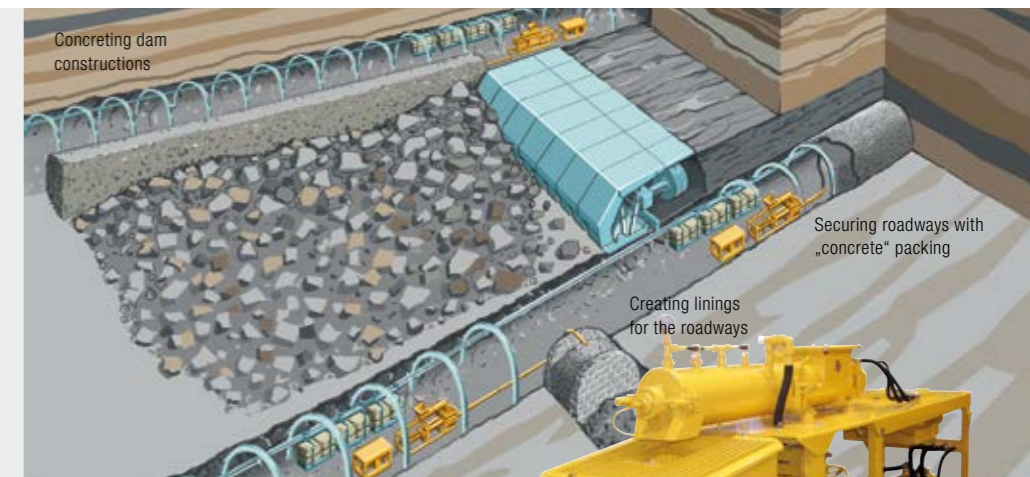

Potential application sites for the BSM 1002



Upward conveyance of sludge with high performance “Mine dewatering”

In “mine dewatering”, mine slurries filled with sand must be conveyed up to the surface. The Putzmeister HSP seat valve pump offers a particularly efficient and inexpensive solution to this problem.

The following case study on a mining company in Lorraine demonstrates some of the economic and technical advantages of this process: The French mining company Houillères de Bassin de Lorraine (HBL) was looking for a better way of pumping its mine slurries with 720 g/litre sand up to the surface from a depth of 1250 m. The 43 centrifugal pumps which they were currently using were reaching their limits as the depth increased. Moreover, their linkage into a cascade meant a fivefold dilution of concentration over the distance to the surface.

To solve this problem Putzmeister plant specialists decided to use two double piston pumps with seat valves (model HSP 3080 with a 320 kW hydraulic drive). This system brought the following results.

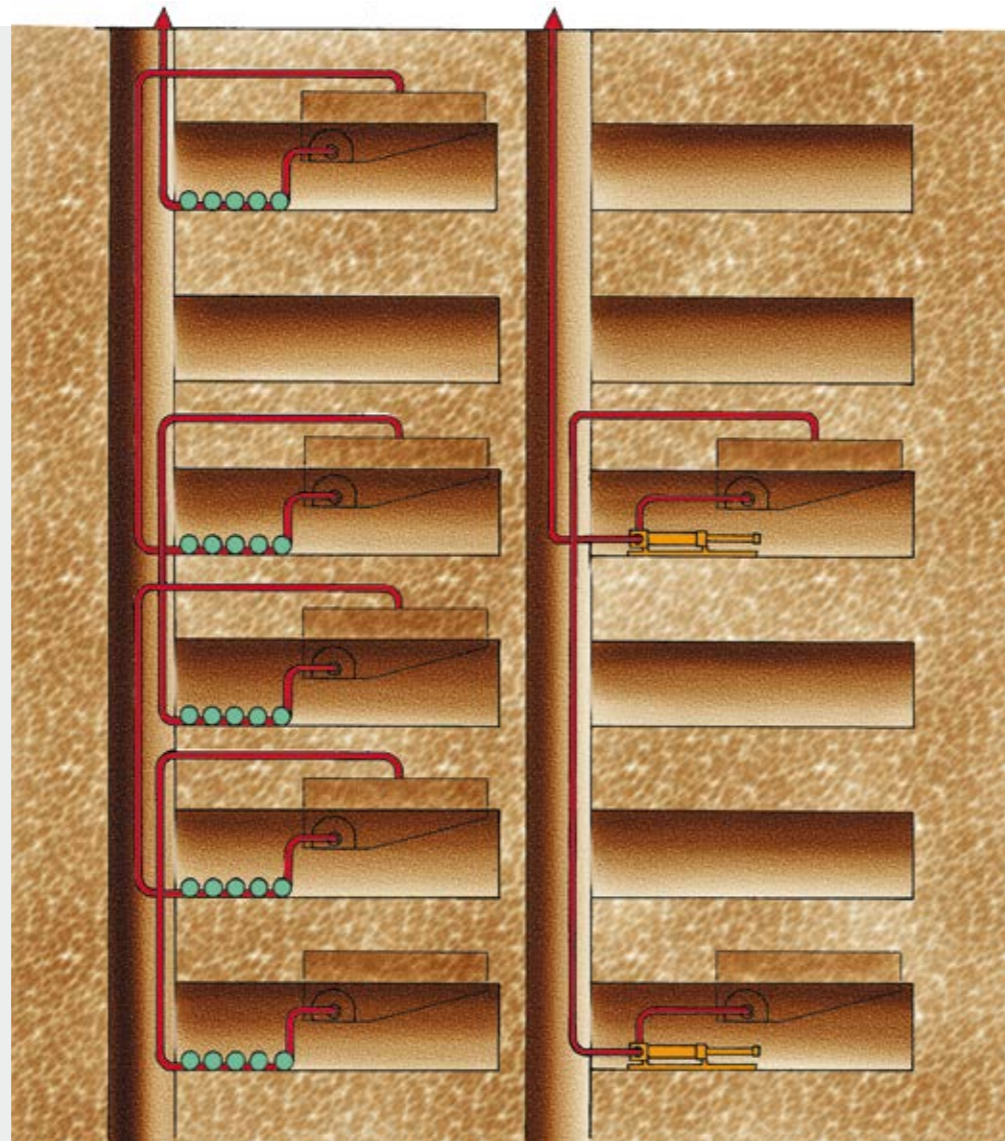

HBL slurry pumping system.
Before: 43 centrifugal pumps –
Now: Only two HSP 3080 solids pumps.

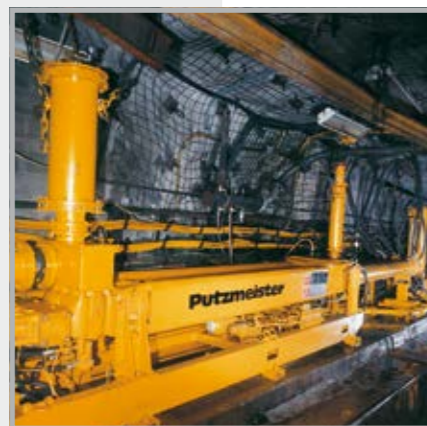

The HSP 3080 at work in an underground site

Advantages of the system

- **Increased capacity – 90 m³/h is pumped at a velocity of 2.7 m/s at a pressure of 100 bar**
- **Constant solids concentration**
- **Energy requirements are reduced to 25 %**
- **Large delivery cylinders guarantee low wear and quiet running**
- **The reliable technology increases availability and considerably reduces maintenance costs**

Fly and bottom ash transport as high-density slurries

After incinerating coal in coal fuelled power stations, the resulting waste such as fly ash from the electrofilters or the bottom ash from the boiler have to be disposed of. The most economic way to convey these different types of ashes is by using Putzmeister KOS double-piston pumps. A mixture of fly and bottom ash can be successfully transported without operational disturbances. Since Putzmeister KOS piston pumps do not have any valves between the inlet and outlet of the pump, even coarse particles can pass through the pump without interrupting the flow process. Another important aspect for using Putzmeister piston pumps is the low water consumption. The pumps operate reliably with high dry solids contents up to 85 %. This translates in an extended lifetime of the disposal site and/or its size can be reduced. The main advantage is however an ecological one: large amounts of contaminated water can be reduced to a minimum.

Solutions from a single source

In order to ensure the efficiency in power stations, Putzmeister offers complete solutions for the conveyance of fly and bottom ash from the tank resp. electrostatic precipitator in landfills. The turnkey supply of ash transport systems consists of silos, mixers, piston pumps, pipework, and includes all necessary accessories and services.

In order to ensure that its systems can be fully integrated in power stations, Putzmeister works closely with the leading suppliers of power station equipment worldwide. Pumping of fly ash, bed ash and sulphurization gypsum are further important areas of application for Putzmeister solids pumps in power stations.

Advantages of the system

- **High availability**
- **Long service life**
- **Low maintenance and operating costs**
- **Low water requirement**
- **Service-friendly**



A KOS 25100 pump installation (Kogan Creek, Australia) for fly and bottom ash

Sludge removal – economic solutions for the environment

Sludge removal and transport

The sludge is removed by shovel excavators and Putzmeister solids pumps. These pumps can operate even with extremely high solids content and there is no need for dilution with water. Particular emphasis is placed here on environmental friendliness and economic efficiency. Experienced engineers come up with the right solution tailored to individual requirements, which is then implemented technically. The rated performance of the PM solids pumps is of decisive importance here.

Operating parameters with solids pumps

- **Outputs up to 400 m³/h**
- **Delivery pressures up to 150 bar**
- **Conveying distances of more than 2000 m**

Putzmeister solids pumps for economic and environmentally friendly solutions

System components

- **Solids pump**
- **Mixing devices**
- **Vibrating screens**
- **Pontons**
- **Floats**
- **Pipelines**
- **Quick-action couplings and fittings**



Sludge handling system operating in a canal in France with an S-tube pump and diesel-driven power pack mounted on a ponton



On the Japanese coast line, three huge KOS 25100 and 25200 piston pumps are pumping silt out of the sea for land reclamation. The Nagoya is now located on this new artificial island.

Advantages of the system

- **In practice, dry solid content in excess of 70 % have been pumped without the need to add water. This means no flushing- or waste water.**
- **This environmentally-friendly and clean transportation solution means that less space is required at the dump site.**
- **Thanks to its gentle conveyance and the material's solid consistency, the sludge dries out extremely rapidly and no dams are therefore required.**
- **Efficient disposal and processing**
- **Conveyance of large foreign bodies**
- **Quick laying of pipeline systems**

Since many components are offered from a single source, we are able to offer efficient and environment-friendly solutions.



River sludge with high dry solids content has short drying times



Desludging of a tar dump using a remote-controlled Dredgemaster dredge vessel



Mobile dewatering and pumping station

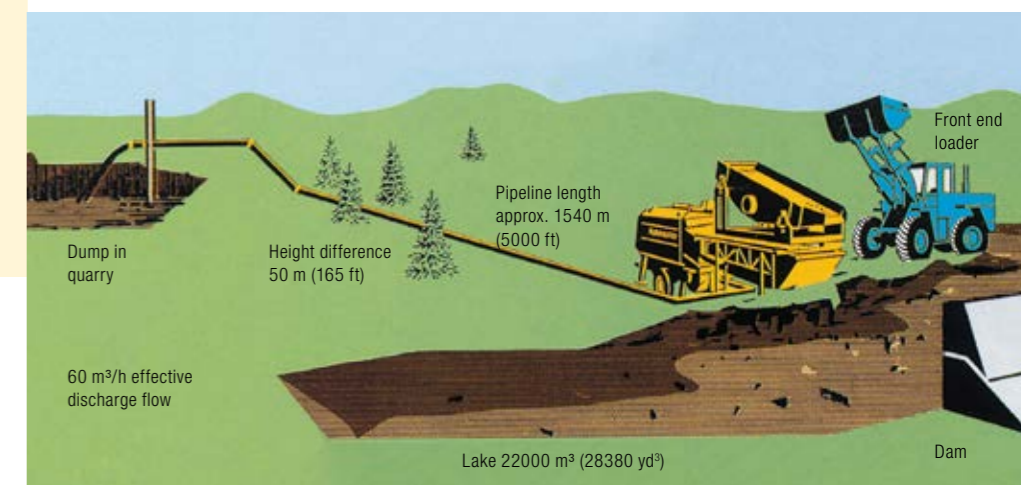

Desludging – Simple and environmentally friendly



Tunnel construction – clean and safe conveyance solutions



"Closed system" muck removal

MPT 40: the compact and powerful muck removal pump for extremely small cross-sections

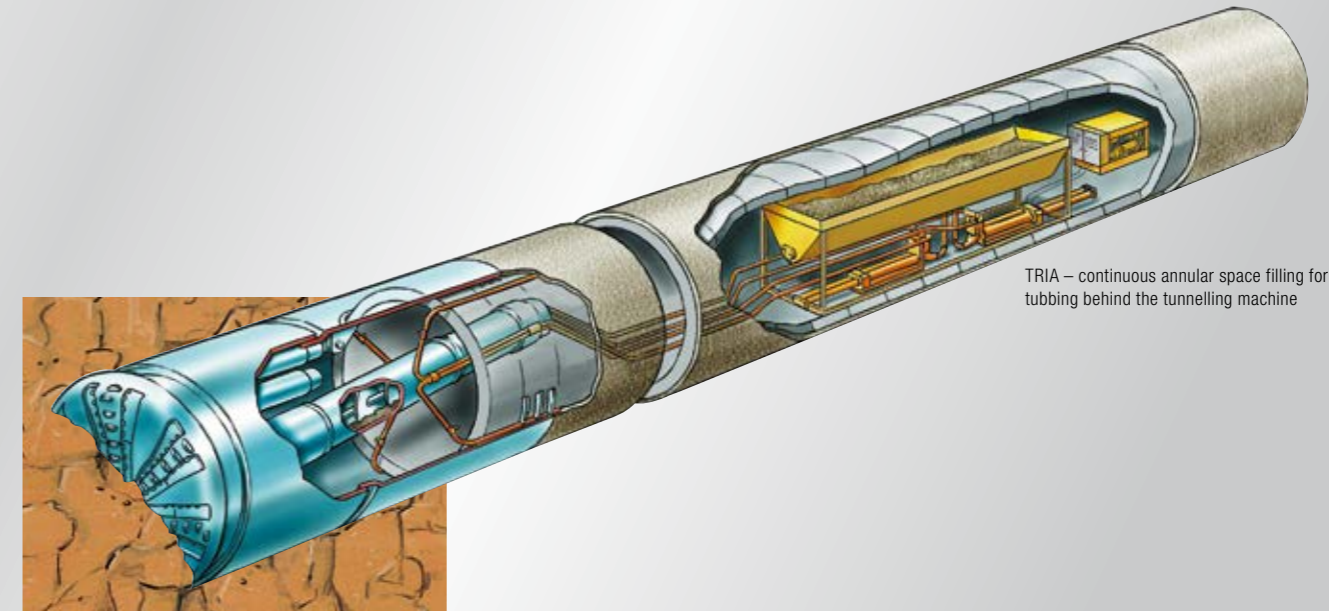

TRIA – continuous annular space filling for tubing behind the tunnelling machine

Conveyance of large amounts of excavation residues

The fact that Putzmeister has mastered the conveying engineering for high density solids and has gained experience from more than 100 tunnel construction projects, makes the company the right partner for complete solutions when conveying muck out of tunnels.

In addition to the comprehensive consulting service offered, machines such as the drive units, crushing and sorting plants, conveying belts, screens, mixing troughs, high performance pumps, silos above ground, etc. are all within the scope of supply.

Double piston pumps provide a performance of up to 400 m³/h per unit. Tunnel machines with up to 14 meters diameter can be equipped with our high density solids pumps. Numerous projects in Asia as well as in Europe (e.g. Botlek Tunnel in the Netherlands) demonstrate the strengths of this method compared to ground transportations by centrifugal pumps or via conveyor belts.

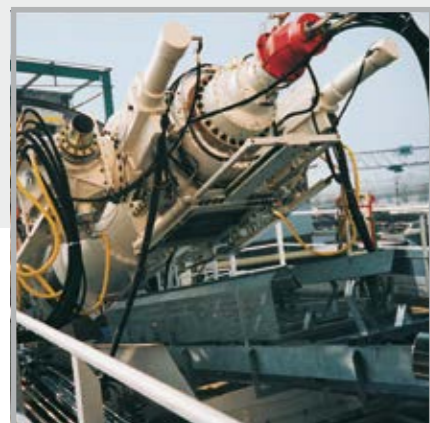

Auger conveyor with two muck pumps of type KOS 1480 (Botlek tunnel, Netherlands)

Advantages of the system

- **Spacesaving, e.g. for driving pipelines in a small tunnel**
- **Clean and safe conveyance of excavated muck over long distances**
- **High output**
- **Addition of water is rare or not necessary**
- **Simple logistics – no muck cars needed**
- **Operational safety**
- **Continuous conveyance is guaranteed, even with pressure locks**

Annular space backfilling for tubing

Depending on rock properties, construction method and time frame, different machines are used in tunnel construction for the injection of mortar. Putzmeister's product portfolio includes everything from the smallest stand-alone machine to fill anchor holes, spiral pumps for low pressures, to piston pumps for pressures up to 100 bar.

In combination with important accessories such as turbo mixers, high pressure valves, high pressure rotor distributors, special delivery lines, auger conveyors, flow meters, pressure gauges, etc., plants can be individually arranged for the most advanced methods. TRIA, i.e. continuous annular space filling for tubing, is often used behind the tunnelling machine.

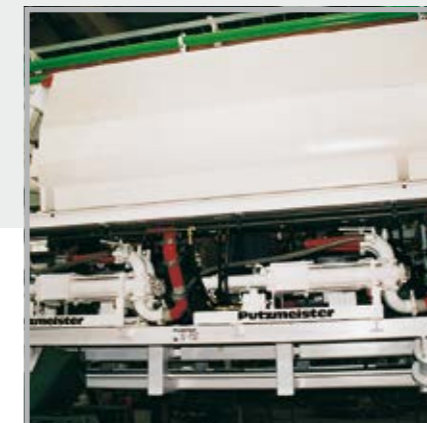

KOV double-piston pumps for freeflowing material containing up to 70 % solids

Inexpensive double-piston pumps with ball valves for the economically efficient conveying of fine-grained mortar and low-consistency slurries containing foreign bodies up to 20 mm in size. High performance ranging up to 70 m³/h and 80 bar mean large safety reserves for the pumping process and allows economic, clean and safe conveyance by pipeline over several kilometres.

Left: A KOV 1050 pumps the injection mortar behind the ring segment
Right: Space-saving installation with two KOV 550 Duo underneath a 6 m³ agitating trough

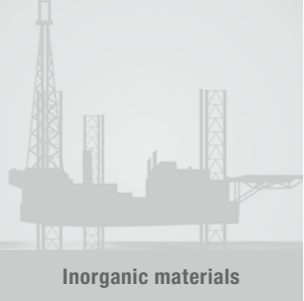

Oil & Gas industry – fitting modular system solutions off- and onshore

Inorganic materials

Conveyance of stiff media with high variance of materials

Pumping with Putzmeister hydraulic driven solids pumps is the most efficient method for conveyance of very stiff material with high viscosity and high share of coarse grain over variable piping systems. The “S-transfer tube” system used in this pump type allows the pumping of material with low liquid content. If the material has poor flow characteristics a special double auger feeder can be used to fill the piston pump type KOS.



Typical Oil & Gas applications for the KOS pumping system

- Pumping drill cuttings from shale shaker to buffer tanks or containers
- Pumping drill cuttings from buffer tanks to the supply vessel
- Storage tanks with discharge and pump systems on supply vessels
- Feeding drill cuttings into processing equipment
- Pumping abrasive slurries

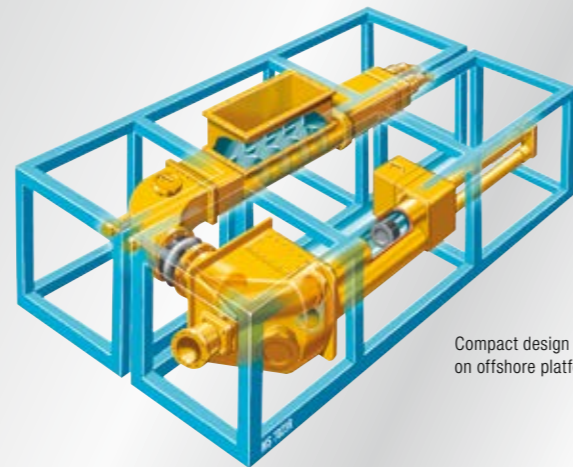

Compact design for applications on offshore platforms

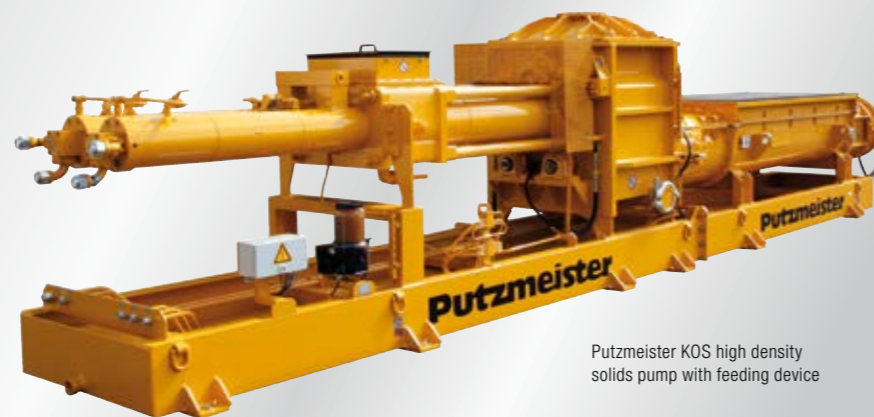

Putzmeister KOS high density solids pump with feeding device

Other key applications

HSP

Oil-hydraulically driven piston pump with hydraulically actuated seat valves for treated drill cuttings.

KOV

Oil-hydraulically driven double piston pump with ball valves for process liquids.



Hydraulic power pack HA 90 S with PCF (Pressure Constant Flow) for pulsation free transportation



Putzmeister KOV 1075 – special equipped for operation with zero leakage

The Putzmeister delivery program for Oil & Gas applications also includes:

- Auger feed units
- Hydraulic power packs
- Delivery pipelines
- Silos and tanks
- Silo discharge systems
- Lubricant injection unit for different media like water, mud, etc.

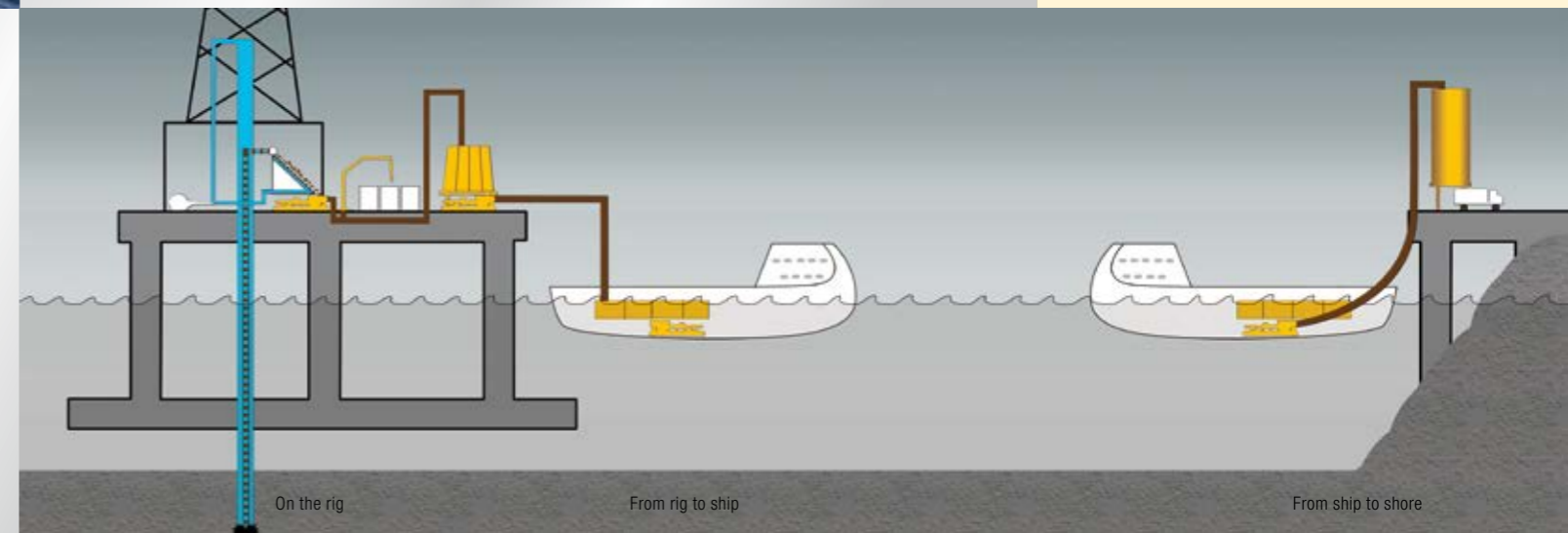

Advantages of the system

- Due to low piston speeds inside the delivery cylinders, the wear is reduced to a minimum
- The maintenance costs and effort are reduced
- Increased availability
- The well designed pump technology, based on Putzmeister's long experience for different applications and pumping of abrasive media

Pumps for this application: ■ KOS ■ HSP ■ KOV



Conveyance of various types of biomasses

Putzmeister industrial engineering has experience with the conveyance of biomass since the end of the 80's. The unique design of the pumps enables to convey various types of biomasses, even when containing foreign bodies such as knives, spoons, bottle caps or glass, which can dramatically disturb the fermentation process.

Opposed to other conveying systems, the treatment of biomass with reduced lifecycle costs is guaranteed when using hydraulically-driven piston pumps. Furthermore Putzmeister also developed a process to separate out foreign particles during the pump process.

A fault-free and non-stalling construction of the pump and feed lines is necessary when pumping biomass, biowaste and foodwaste from households, supermarkets, restaurants or other sources. Everything that disturbs the flow can lead to clogging or blockages.

Dry-anaerobic fermentation of biomass

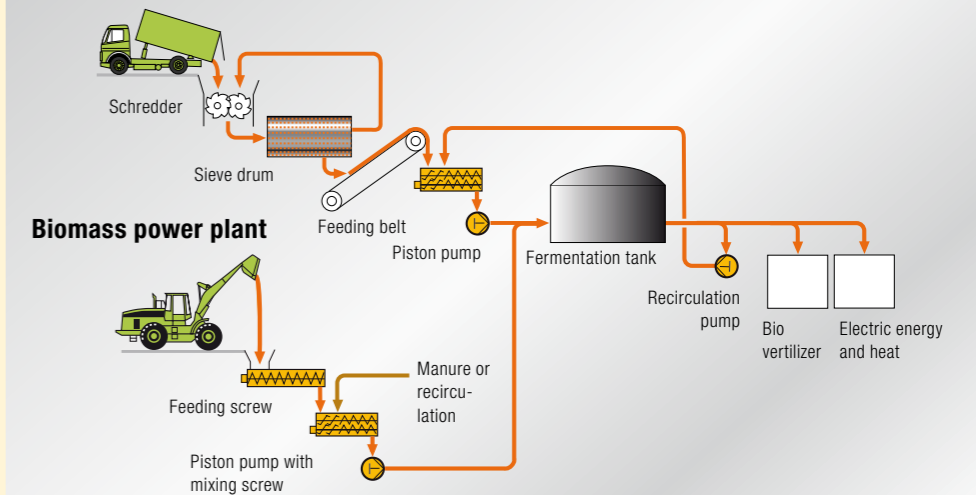

Biomass from food remains and wrapped food

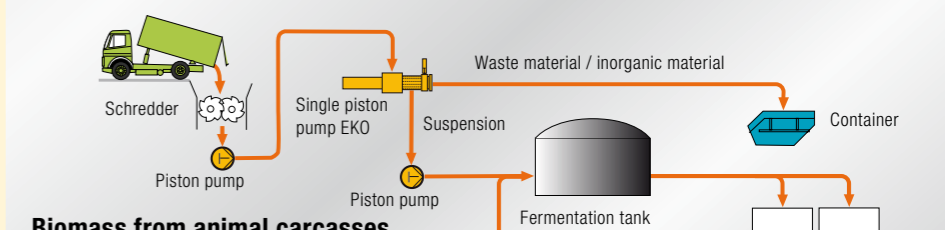

Biomass from animal carcasses

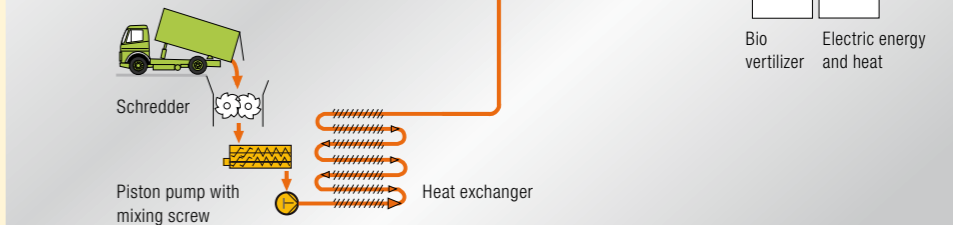

KOS 25100 with hydraulic power pack and twin-screw feeding device, transporting biomass to the fermentation tank





Biogas from waste – for a cleaner environment

An EKO 1060 PP in a biomethanisation plant (Kössen, Austria) for unwrapping and transporting foods past expiry date



Conveyance of pasty material with large grain size

In accordance with EU 1774, using leftover foods as animal food is no longer allowed in Europe. These are now converted into electrical energy and heat in biogas plants. The KOS twin-cylinder piston pump can pump bulky, wet and pasty material with large grain size.

- **KOS twin-cylinder piston pumps have been pumping more than 160000 hours without any major interruptions.**

The KOV twin-cylinder piston pump can convey wet material. Due to having a large inlet and outlet opening, this pump type can also digest large particles without disturbing the pumping process.

- **KOV twin-cylinder piston pumps have been pumping more than 100,000 hours without any major interruptions.**

The alternative option for producing electricity and heat out of biomass



Biowaste recycling plant in Varenne-Jarcy, France: KOS 2180 pumping biomass into a fermentation plant



Efficiency through the separation of foreign particles

During the methanisation of biomass (left-over and/or expired foods or other organic waste), inert foreign bodies such as wrappings/packagings, plastic trays, glass, cans, or metal can disturb the biogas process since those foreign bodies reduce the active volume in the fermenters.

With the EKO single cylinder piston pump, in order to improve the fermentation process, it is possible to reliably separate foreign bodies before feeding the organic waste into the fermenter. The EKO can deal with wet material, as well as sludges containing large foreign bodies.

- **EKO single-piston pumps have been pumping more than 60000 hours without any major interruptions.**



Leftovers and expired foods before processing



Substrate of the biomass after the pressing process of the EKO 1060 PP



Remaining packaging and foreign bodies



Sewage treatment plants – the economical and reliable solution

Disposal of sewage sludges

In sewage treatment plants, Putzmeister solids pumps will help dispose of the thickest types of sludge. Even solid content as high as 45 % are not an issue. Plants impose strict requirements when it comes to running a fault-free continuous operation. This is precisely where Putzmeister solids pumps have proved themselves world-wide, proving their economic efficiency in the conveyance of mechanically dewatered sewage sludges.

Conveyance through a closed pipeline

- **Odourless**
- **No environmental pollution**
- **Space-saving and can be adjusted to fit the existing structure of the buildings**
- **High metering accuracy**
- **Pipeline is not subject to wear**
- **Low-maintenance and low-wear technology**
- **Maximum availability for continuous unmanned operation**
- **Remote supervision from the control room**
- **Stiff, liquid and sticky sludges can be transported**

Leaders in pump and silo technology

The best features of Putzmeister piston pumps:

- **Robust design**
- **Flow-optimised suction characteristics**
- **Continuously filled, circular suction cross section in the S-transfer tube**
- **High volumetric efficiency for the delivery cylinders**
- **Long piston strokes**

To improve the efficiency, it is possible to extend the Putzmeister piston pumps with a feeding device which is equipped with self-cleaning augers and supports the optimal filling of the delivery cylinders.



KOS 1050 solids pumps in the ProReno sewage treatment plant in Basel

Putzmeister's silo technology

The silo technology with sliding frame has been especially developed for dewatered sewage sludge. The silo can take up to 1000 m³ sludge and reliably feeds it to the pumps. From the various pump models to the silos and the corresponding fittings and accessories, Putzmeister can provide complete solutions for conveyance tasks in wastewater treatment plants.



Sewage sludge reception station consisting of reception and storage silos: Incineration of foreign sludge at the main wastewater treatment plant of Stuttgart-Mühlhausen

Advantages of the system

- **Low life-cycle costs**
- **High operational reliability**
- **Extremely quiet in operation**
- **Can handle the stiffest sludges, even hot (up to 100 °C)**

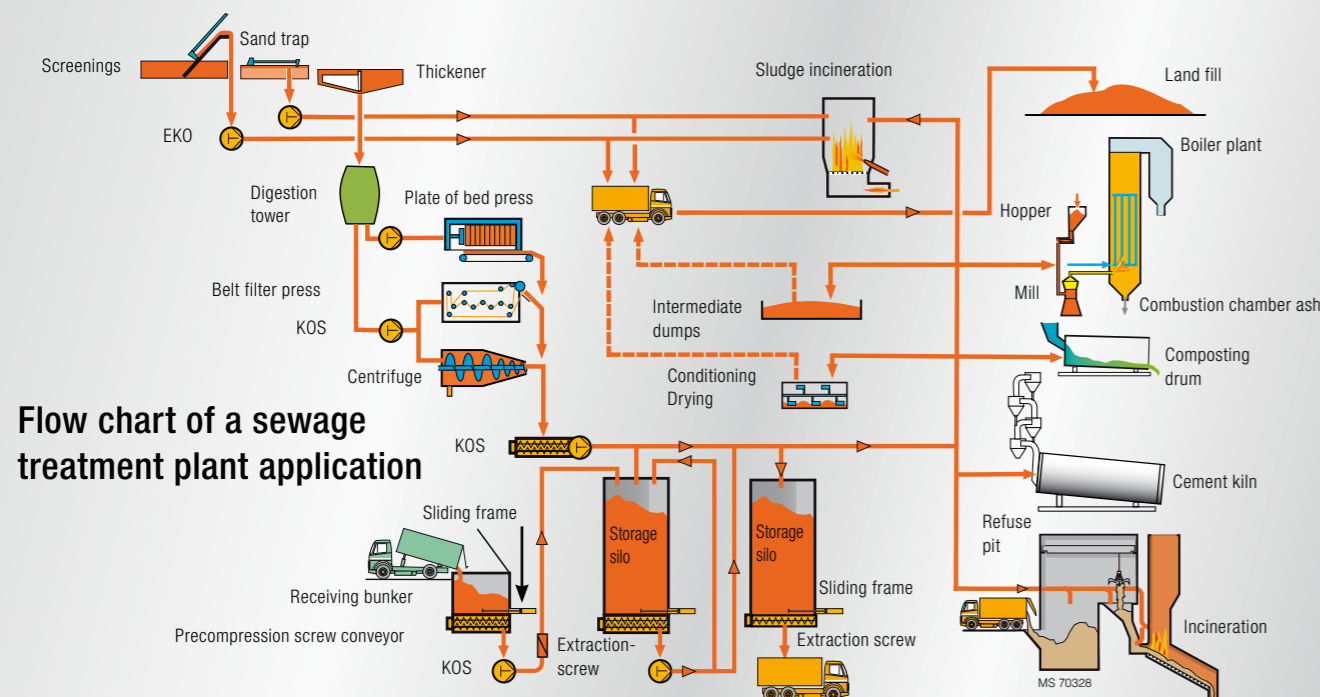

Flow chart of a sewage treatment plant application

Pumping screenings (Coney Island, New York)



Screenings



Sewage sludge dewatered by a chamber filter press: Solids content > 35 % DS



Pumps for this application: ■ EKO ■ KOS ■ HSP



Co-Incineration – efficient energy generation

Conveyance of sewage sludge and household waste

The disposal of dehydrated sewage sludge in household waste incineration plants is nowadays a very environmental friendly and economical procedure.

This process can be integrated in newly planned plants, as well as retrofitted in older plants. The addition of sewage sludge does not affect the reception of household waste or the discharge and metering of rubbish into the the combustion chambers. Besides the fact that both materials are burnt together, there is no common interface between both disposal lines.

Putzmeister offers complete turnkey solutions for storage, transport and feeding of refuse in the combustion chambers.



Two KOS 1030 with HA 22 for feeding sewage sludge into the refuse incinerator (Dinan, France)

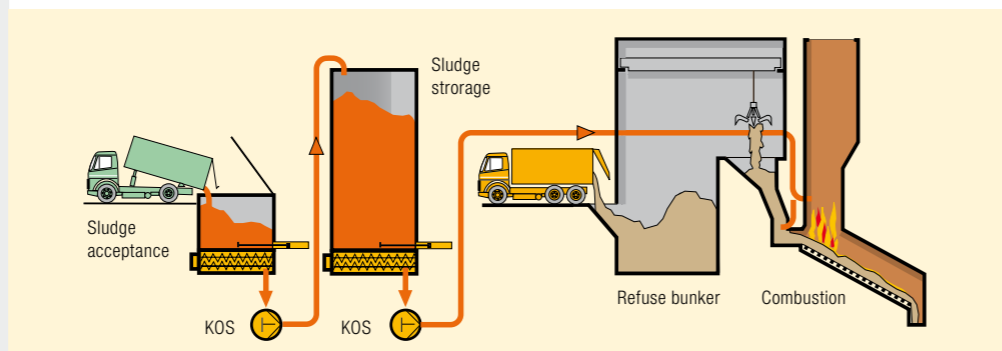

Flow chart: Sewage sludge co-incineration in household incineration plant

Efficient coalfuelled power plants

The co-incineration of mechanically dewatered sewage sludge in existing coal-fuelled power stations with highly effective flue gas pollution control is also an economic and meaningful alternative that do not pose a threat to the environment compared to the previous disposal methods.



Co-incineration of sewage sludge in the coal-fuelled power plant of Zolling (Germany): KOS 2180

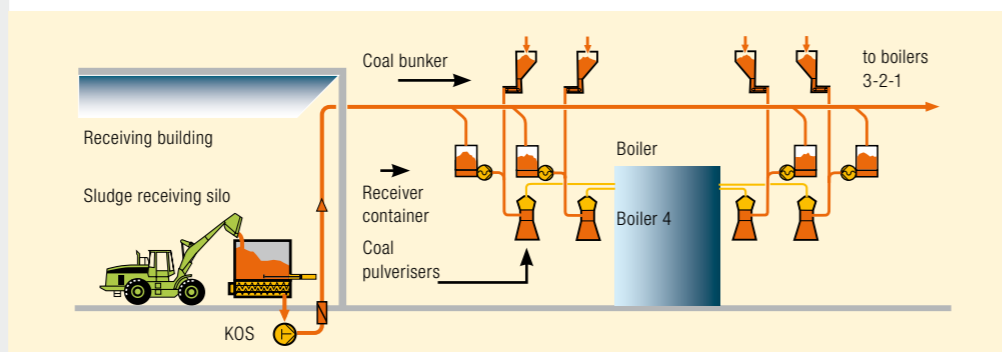

Flow chart: Co-incineration of sewage sludge in a coal fired power plant

Well-thought-out planning process

Recycling the amounts of received sewage sludge from municipal and industrial plants has become an important issue for sewage treatment companies.

Due to political framework conditions (prohibition of dumping sewage sludge, limitations placed on agricultural use, etc.), the choice of a thermal incineration to dispose of sewage sludge has become inevitable.

To ensure that the multiple hearth furnaces are used to their full capacity, not only one's own sewage sludge can be handled but also external sludge from surrounding wastewater treatment plants can be receptioned and treated. Putzmeister Solid Pumps offers complete sludge handling systems for such purposes.

A special advantage of the KOS S-tube pump without valves

- Foreign bodies contained in the sludge can be conveyed without interference thanks to the large cross-section opening of the S-tube pump.



Erzo Oftringen sewage treatment plant (Switzerland): rotary kiln for the incineration of sewage sludge

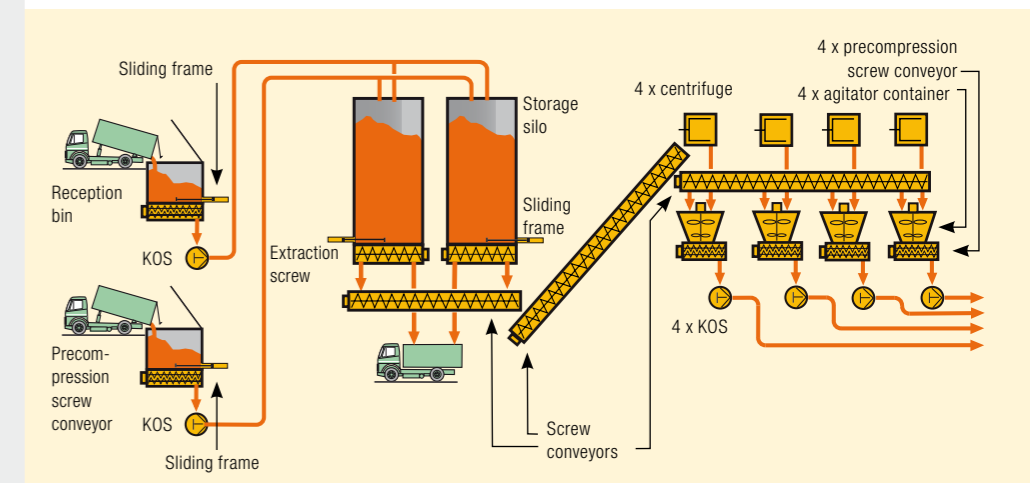

Flow chart: Reception of foreign sludge and handling one's own sludge in a sewage treatment plant



Two 200 m³ storage silos for sewage sludge storage (Pro Rheno, Switzerland)

Pumps for this application: ■ KOS

Coal-fuelled power plants – providing the right support to a clean coal technology

Feeding of fuel into the fluidized-bed

This technology distinguishes itself by its environmental friendliness and a higher degree of efficiency compared to conventional coal-burning processes. Putzmeister is making a major contribution towards clean power stations. Putzmeister KOS pumps feed fuel, in form of a coal-limestone-water mixture, into the fluidized bed. Depending on the material's granular structure, solids content of over 85 % are pumpable. The pumps offer a reliable, maintenance-free and continuous mode of operation.



Above: Coal sludge reception system in a power plant
Below: KOS 2180 coal transportation pump for longdistance coal delivery



Complete system: from the reception silo to the boiler

Case study: The installed Putzmeister pumps in the commercial power plant of Värtan, Stockholm have been running fault-free during the heating period, lasting 6500 hours in Sweden. Each of the 12 injection pumps is working for more than 90,000 hours.



KOS 1070 coal sludge injection pump

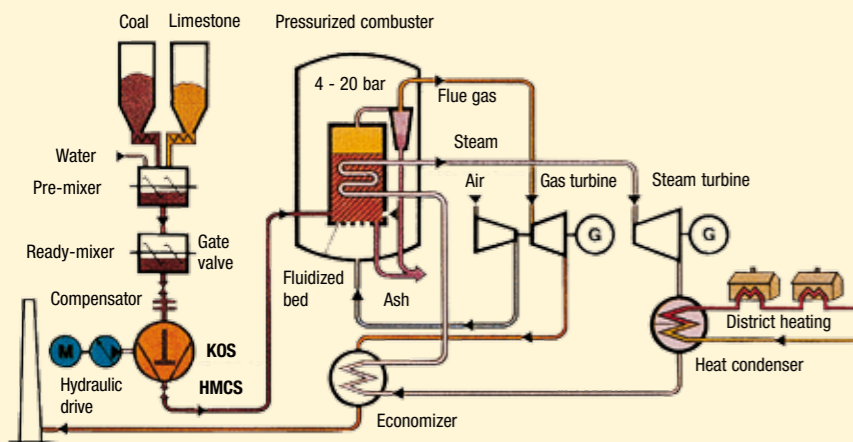

Coal injection with pressurized fluidized-bed combustor. The flow chart shows a combined gas and steam turbine process with pressurized fluidized-bed combustion. (ABB Carbon)

Cement industry – cost-effective production with substitute fuels

Conveyance of substitute fuels

Substitute fuels offer cost-saving opportunities for energy-intensive industries. With the example of the cement industry, Putzmeister Solid Pumps offers solutions comprised of silos and pumps that support the reception and conveyance of alternative fuels for the production of cement.

Alternative fuels will have a high calorific value in order to be a worthy substitute to primary energies. Possible fuels for such purposes are mechanically dewatered sewage sludge, tar, paint sludge and slaughterhouse waste

These fuels are receptioned in silos, either individually or mixed together. The Putzmeister high density solids pumps then convey the substitute fuels, either to the cold side of the rotary kiln as additives or source of energy; or to the hot side as fuel.

It does not matter if there are foreign bodies in the material since the Putzmeister S-tube technology is able to convey those even if they represent 2/3 of the size of the pipeline diameter.

However, these alternative fuels have to be processed before they are pumped, meaning that they have to be made pumpable beforehand. The volume to be fed into the cement kiln is approx. between 2 and 7 m³/h.



Co-incineration of alternative fuels in the cement plant of Lafarge in Le Teil, France



Sludge from cooling-water treatment



Paint sludge

Three types of stations for an efficient sludge handling system

Type 1
The receiving station consists of high density solids pumps with a precompression screw conveyor and a built-in attachable hopper handling volumes between 6 and 10 m³. The pump is fed with a front-wheel loader.

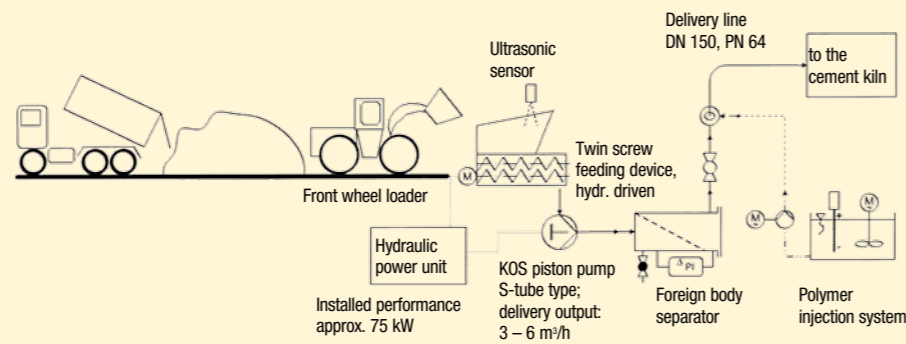

Type 2
In this option, the attachable hopper is replaced by a receiving silo with a volume of approx. 100 m³. Different sludges can be received and stored in a 100 m³ reception silo simultaneously.

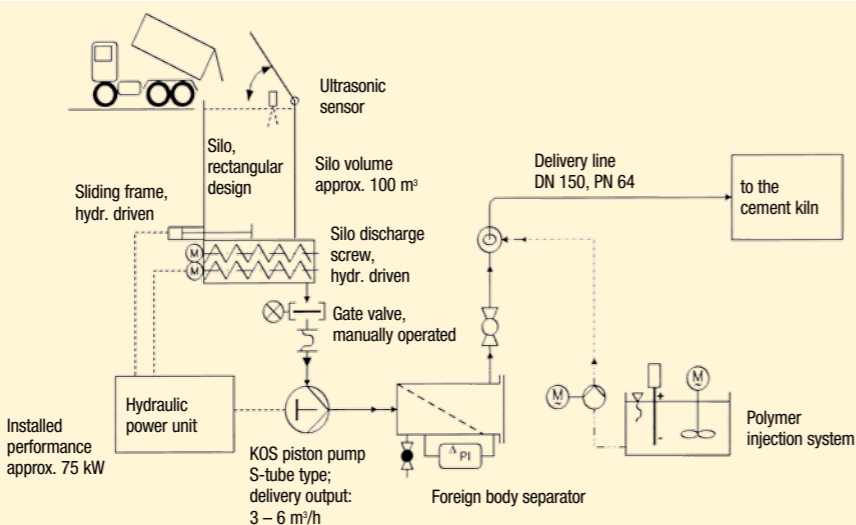

Type 3
Different alternative fuels can be received in one or multiple receiving bunkers. High density solids pumps then convey the material to a 250 m³ storage silo. Hence, the receiving bunker is ready for new deliveries of sludge.

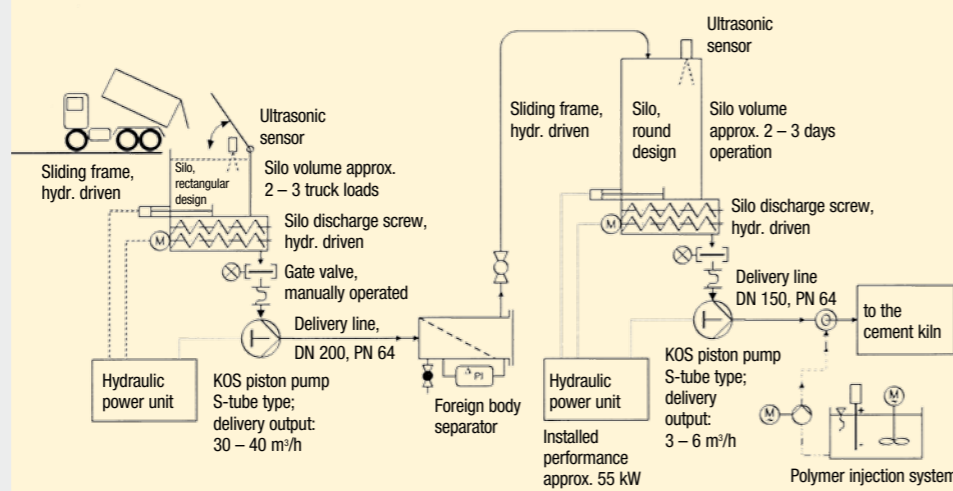

Hazardous waste treatment

When conveying hazardous waste, it is important that none of these dangerous substances get into the environment. Health risks have also to be avoided on the premises of the plant. This can only be guaranteed when conveying through a closed pipework system. Special requirements made by the legislators, such as ATEX and explosion protection are implemented in the Putzmeister systems.



EKO 14100 feeding the rotary kiln with shredded barrel waste in a hazardous waste treatment plant

Coarse hazardous waste from the reception bunkers is fed via claw arm to the EKO piston pump

Flow chart: Incineration plant for hazardous waste



Optimized incineration

Through a controlled pump feeding, it is possible to monitor the incineration process of the substances in order to respect the exhaust gas permissible values.

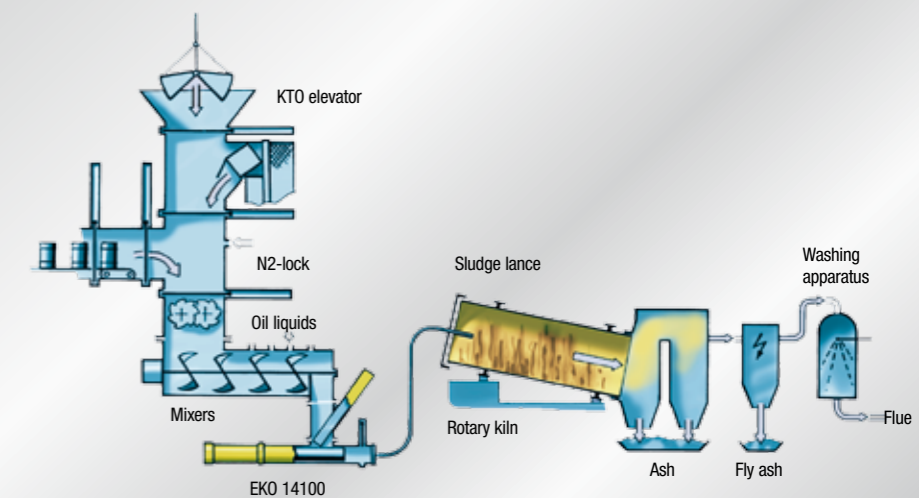



Oil-hydraulic double-piston pump with S-transfer tube

In the KOS series, the intake (for connection of the delivery line) and the delivery cylinders are connected by an S-transfer tube. This enables a freeflowing conveyance of the material without the use of valves. Foreign bodies up to 2/3 of the size of the discharge outlet can be conveyed without any issue.

The KOS pump is particularly suitable for conveying highly viscous sludges and other material with a high proportion of extraneous material. The main fields of application of the KOS are with materials which present the most extreme requirements, such as dewatered sludges containing solids, oil sludges, high-viscosity solids and so on.

For extreme applications, a wide range of task-specific components and functions are available from Putzmeister.

The pump's simple design and the few wear parts offers a very robust, low maintenance pump with low operating costs.

For further information please refer to our IP 1082 GB brochure



Features and advantages

- For conveying coarse sludges or slurries with a high grain-size content
- Low maintenance and wear due to fewer moving parts
- Less suction resistance thanks to larger inlet permitting constant freeflow of the material
- Continuous material flow due to the large discharge diameter
- The hydraulic circuit of the S-tube does not come in contact with the material being pumped
- Delivery rates up to 400 m³/h
- Delivery pressures up to 150 bar

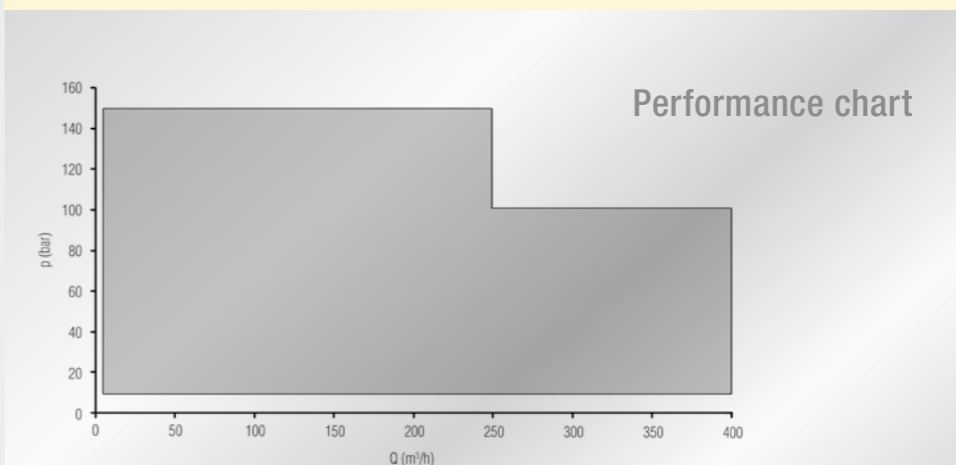

Oil-hydraulic piston pump with seat valves

The seat valve pump is used for heavy tasks. The HSP series is used with paste-like and highly viscous material with a low content of foreign bodies and small particle sizes (< 8 mm).

Precise sealing of the valves means that extremely high pumping pressures can be achieved. The principle behind the design of the hydraulic and pumping pistons is the same as in the Putzmeister KOS and KOV series. This ensures maximum reliability and availability.

Two special features of the Putzmeister design are that not only is it a simple matter to replace the valves but the design also means a long service life for all wearing parts. Valves and valve seatings are made of highly wear-resistant steels and can be partly used at either end. This doubles their service life. Valves can be easily replaced without dismantling the delivery lines.

All of the familiar Putzmeister options and variations are available with the HSP series as well.

A pulsation-free conveyance can be achieved with the PCF system (Pressure Constant Flow)

For further information please refer to our IP 1971 GB brochure

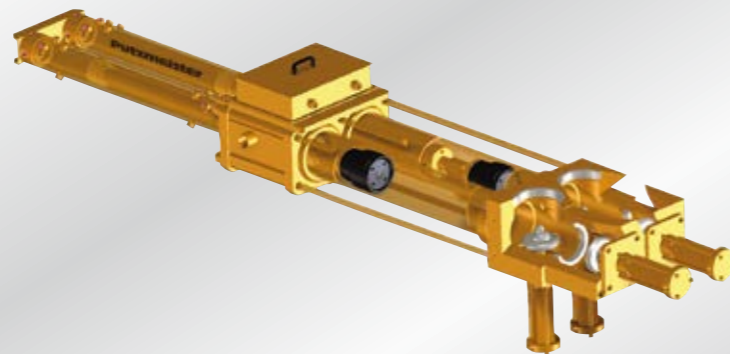

Features and advantages

- For conveying fine-grained sludges or slurries
- Switch-over without shorting
- No backflow at high pressures
- Easy installation of damping tanks
- PCF system for an almost pulsation-free conveyance
- Outputs up to 250 m³/h
- Delivery pressures up to 150 bar

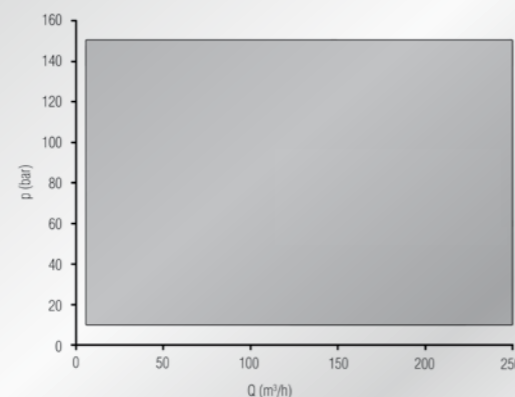

Performance chart

Oil-hydraulic piston pump with ball valves

The KOV series is characterized by its straightforward design and high reliability. The suction and delivery cylinders are connected by indirectly operated balls.

No elements are actively operated, which makes it an inexpensive pump with maximum availability. There are no issues or complications when pumping paste-like material such as mortar or bentonite, even when they contain foreign bodies up to 10 mm in size. Pumping pressures up to 80 bar and an output of 70 m³/h can be achieved.

Depending on the specific individual case, the balls and seat valves can be supplied in different materials and coatings. A maintenance aperture allows an easy and rapid replacement of the ball valves.

For further information please refer to our IP 1027 GB brochure

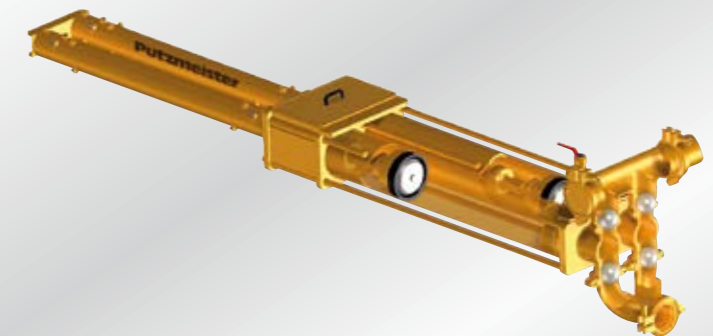

Features and advantages

- For conveying fine-grained pastes
- Simple design
- Minimal of moving parts
- Very easy to maintain
- Outputs up to 70 m³/h
- Delivery pressures up to 80 bar

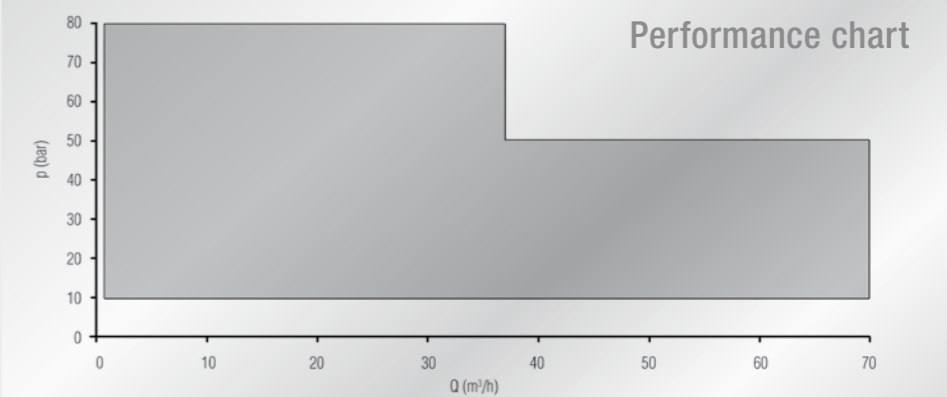

Performance chart

The oil-hydraulic single-piston pump

The EKO series is designed for the most extreme pumping tasks. The open hoppers allow extremely dry material containing a high proportion of foreign bodies to be fed into the pump. Materials which were un-pumpable until now, such as highly de-watered paper sludges, are thrust by the hydraulically driven piston into the delivery line.

The EKO Crown model is equipped with a delivery piston with a hardened toothed cutting crown. This pump is used when the material contains large-sized foreign bodies, which would swiftly result in blockages in other systems. The EKO pumps and cuts in one single operation. The most difficult materials, such as sewage treatment plant screenings or shredded barrel waste in special waste incineration plants, can be pumped without issue into the delivery line.

A near continuous operation is also possible with the double EKO version.

For further information please refer to our IP 2253 GB brochure



Features and advantages

- For conveying large-sized and coarse foreign bodies
- For conveying extremely stiff material
- Crown version – pumping and cutting in one stroke
- Simple design
- Delivery pressures up to 60 bar
- Cutting force up to 80 t
- Outputs up to 14 m³/h

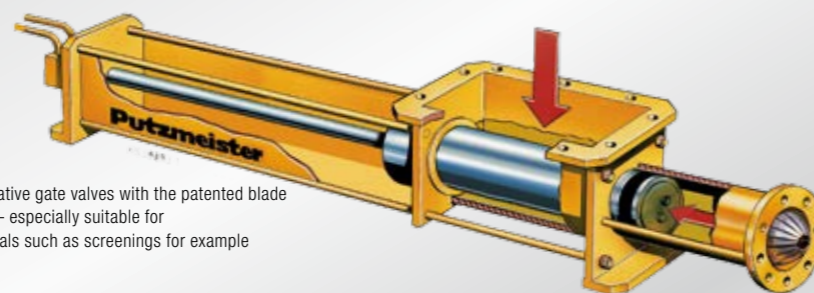

Alternative gate valves with the patented blade valve – especially suitable for materials such as screenings for example

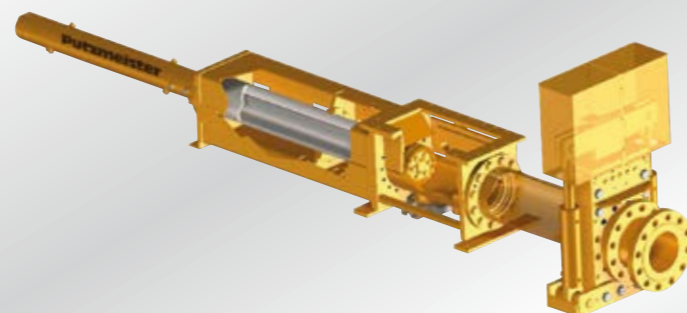

The heart of every piston pump

These power packs have proved their effectiveness more than 10,000 times with concrete pumps and now they power up industrial pumps that convey the material.

They drive the following:

- High density solids pumps of type KOS, HSP, KOV, EKO
- Screw conveyors of type THS, SHS
- Silo sliding-frame of type PDL, PDF, PDS-L, PDS-F
- Accessories such as gate valve or silo-lid, etc.
- Performance classes from 5,5 kW up to 1800 kW and more are available

Efficiency of the hydraulic system design

Depending on the quantity of oil needed, an open or closed oil-circuit can be used. The closed oil-circuit is used when reaching large delivery capacities, which means considerable cost-savings.

The oil-circuits are designed for hydraulic pressures of up to 300 bar. This equals delivery capacities of up to 150 bar, for a short time up to 160 bar.



Features and advantages

- The power of the hydraulic gives the delivery cylinder the necessary pressure to pump the material into the delivery line.

Equipment (partly as option)

- Electric motor for all common voltages and frequencies (up to 10 kV, 50 or 60 Hz)
- Diesel engine
- Oil/air cooler
- Oil/water cooler
- Oil pan / separation bar for hydraulic connections
- Sound insulation
- Inline design of hydraulic pumps
- Monitoring sensors (pressure, temperature, filling level)
- Oil filter
- Terminal box
- Manometer



Receiving bunker with rectangular sliding frames and pump feeding

Storage silo with truck loading

Storage silo discharging directly into a pump

Combination – pump and silo

Putzmeister silos have been designed especially for highly dewatered and viscous sludges. Since the pump and silo come from the same manufacturer, the customer enjoys important benefits:

- **The shared silo discharge and pump feeding auger reduces costs and increases availability.**
- **The perfect tuning between pump and silo leads to an overall optimized concept.**
- **No interface clarification necessary, the customer does not have to deal with sub-suppliers.**
- **Individual installation planning, tailored to the space available and the customer-specific requirements**

Sliding frame systems

The Putzmeister sliding frame system has been designed especially to meet the requirements of harsh three-shift operation. Thanks to modern Finite Element Analysis and proven Putzmeister hydraulic components the sliding frame's design, as well as its service life is optimized.

One major feature is the space-saving design emplacement of the sliding frame's piston rod which is located on the silo floor.

Ladder systems / discharge systems for round silo

Depending on your application, the sliding frame can take the form of a ladder system (PDL) or a cylindrical silo discharge system (PDF). The ladder system with multiple parallel sliding frames is particularly suitable for wide or long receiving bunkers. This ensures an efficient transmission of force and increases the availability of the system thanks to the redundancy.

The product range includes silos and bunkers from 10 m³ to 1,000 m³ for loading trucks and for feeding sludges to solids pumps and their onward conveyance.

Material is discharged from the silos by means of specially adapted screw conveyors, with a lateral or central discharge. If several end users have to be supplied, multiple discharge augers can be used.



Finite element analysis for the sliding frame

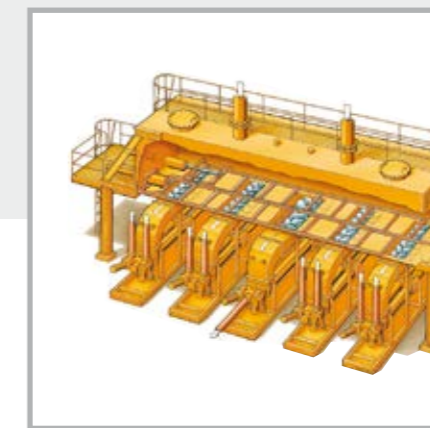

Intermediate silo with double rectangular sliding frames for charging five Putzmeister solids pumps

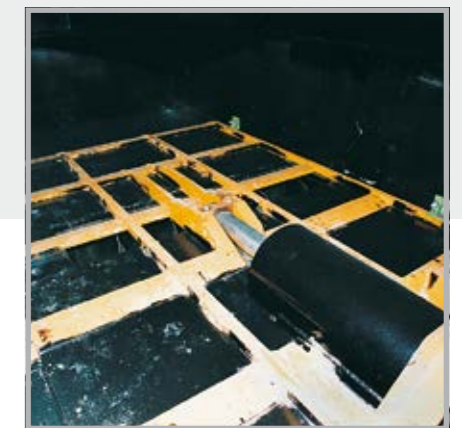

PDL rectangular discharge sliding frame

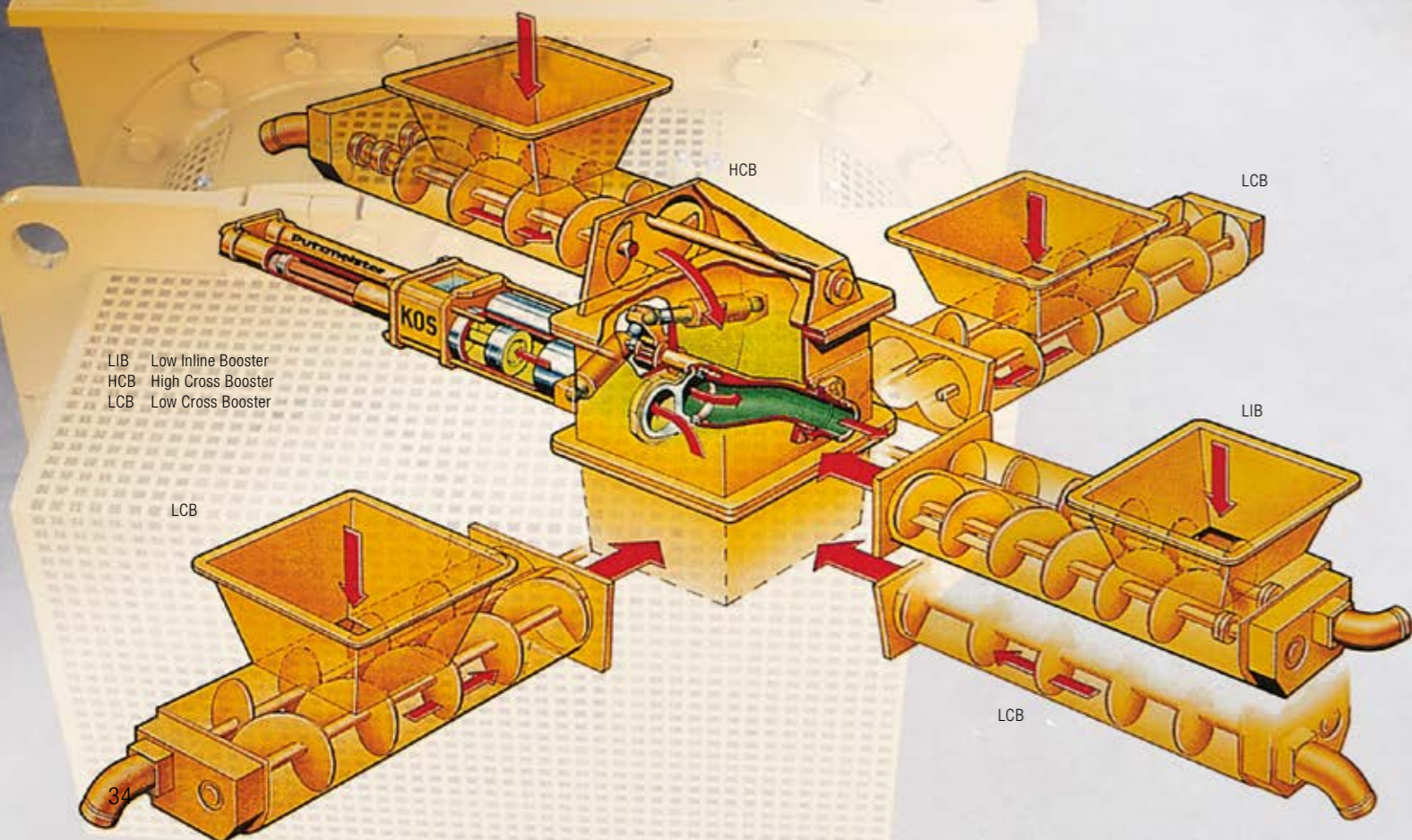

Filling through screw conveyors

Highly-viscous sludges have to be fed to the pump if they cannot flow by themselves into the pump. This task is best resolved with twin-screw augers. The latter will generate a pressure in order to fill the pump more efficiently with the material to be conveyed. A further positive effect is that the twin-screw augers are self-cleaning since they are meshingly inter-connected. They are driven hydraulically.



Twin-screw auger feeding device with mixing paddles in the supply chute



Advantage of the hydraulic system

- In every speed range, the screw conveyor's drive can exert its maximum torque on the material to be conveyed



Twin-screw conveyor SHS 3262 SH

Foreign body separators enable a continuous flow of material

Putzmeister's FKA 200 is successfully used with the conveyance of sludges containing foreign bodies. This system protects downstream machines from disturbing materials. Thus, when incinerating sewage sludge in coal-fired power plants, problems

can be avoided in the downstream operating coal-fired boiler. In the direction of the flow, the foreign bodies will be caught by a grid. The foreign body separator is equipped with a quick-release fastener which can be opened through a single-lever operation.

The quick-release fastener system ensures additional safety during the cleaning operation of the foreign body separator



Left: Retained foreign bodies
 Right: Foreign body separator in a power plant

Delivery lines in tunnelling and mining

Delivery lines for underground construction sites must be easy to lay, safe and be capable of high-pressures.

The Putzmeister Zentrifix® ideally meets these requirements. The rigid and absolutely leak-proof connections act just like hydraulic connections since the seal is tightly pressed into its seat during the assembly. The large wall thickness with the ZX lines additionally offer a high wear reserve. ZX delivery lines are used for backfilling, mine dewatering and for transporting concrete over long distances.

Further underground tasks are shotcreting, as well as injection works. Here, SK quick-action coupling system, as well as the Ultraflex® PX system are used.



Tunnel concreting with flexible SK pipe-lines as expansion pipes

Delivery lines in industry

Delivery lines in industry must especially be safe over a long period of operation. The pressure resistance with pulsating load is one particular criteria when designing the delivery line. The Zentrifix® system was modified for this operational purpose. The so-called ZX-IP lines have proved themselves worthy for abrasive and non-abrasive materials. ZX-IP lines are used in sewage treatment works, in coal-fired power plants, waters desludging, in mining and other numerous special applications.

Depending on the application, the design, material and the surface treatment can be modified in order to be ideally adapted to the pump and material to be conveyed.



Safe laying of horizontal delivery lines with Zentrifix®

Ball, gate or diversion valves

Delivery line components must be designed regarding the dynamic loads and characteristics of the media. Ball valves for example are therefore equipped with stronger shaft shanks and flush connections.

Gate and diversion valves are essential when multiple delivery lines have to be installed. Thus, the material located in the pipeline after the pump can be diverted through a gate valve to other routes such as a thermal dryer or intermediate storage.

Gate valves are hydraulically operated. For a faster switch, it is suggested to use a power pack of at least 7,5 kW. The valve housing is sealed with hardened sealing rings, that are pressed against the moving blade of the valve



Gate valves for there different delivery lines



Above: Boundary layer injection
Below: Injection site of the lubricant



The injection of water or lubricants significantly reduces the pressure loss in the delivery line Example: Sewage sludge with 37% and up to 47% dry solids content

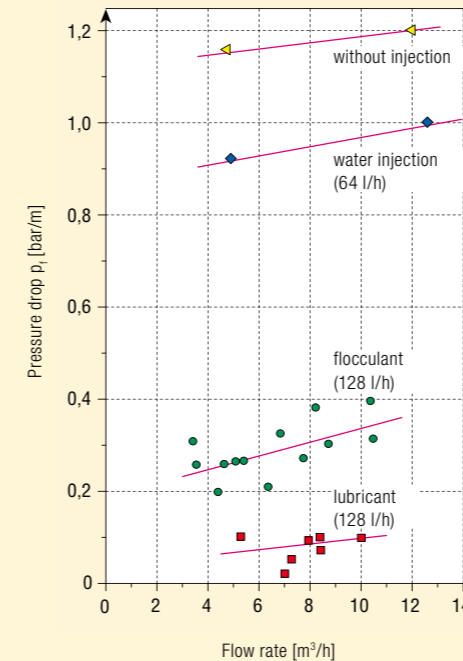

Continuous flow of material thanks to injection systems

Sometimes, for hard-flowing materials, unfavourable material consistency, high installations, long conveying distances, there is the need for delivery pressures that are higher than what high density solids pumps can deliver. High delivery pressures can be reduced through injection and thus an economic conveyance of specific materials can be guaranteed.

A lubricating film, reducing the delivery pressure, is created when injecting water, oil, mud or lubricant in the delivery line.

A small amount of liquid or lubricant is equally injected via a nozzle ring on the inner-surface of the delivery line. A boundary layer injection unit with dosing pump is needed for a continuous and automatic injection of the lubricant. The lubricant dosing pump sucks the mixture from a tank and, independently from the pump's delivery pressure, injects it in the delivery line. The amount of lubricant is reduced or increased according to the changing delivery pressure of the pump which is in turn optimized.

With special lubricants, it is possible to reduce the pressure in the delivery line by up to 2 % of the initial value. Lubricant amounts between 0,1 and 1 % of the pump's delivery volume injected.

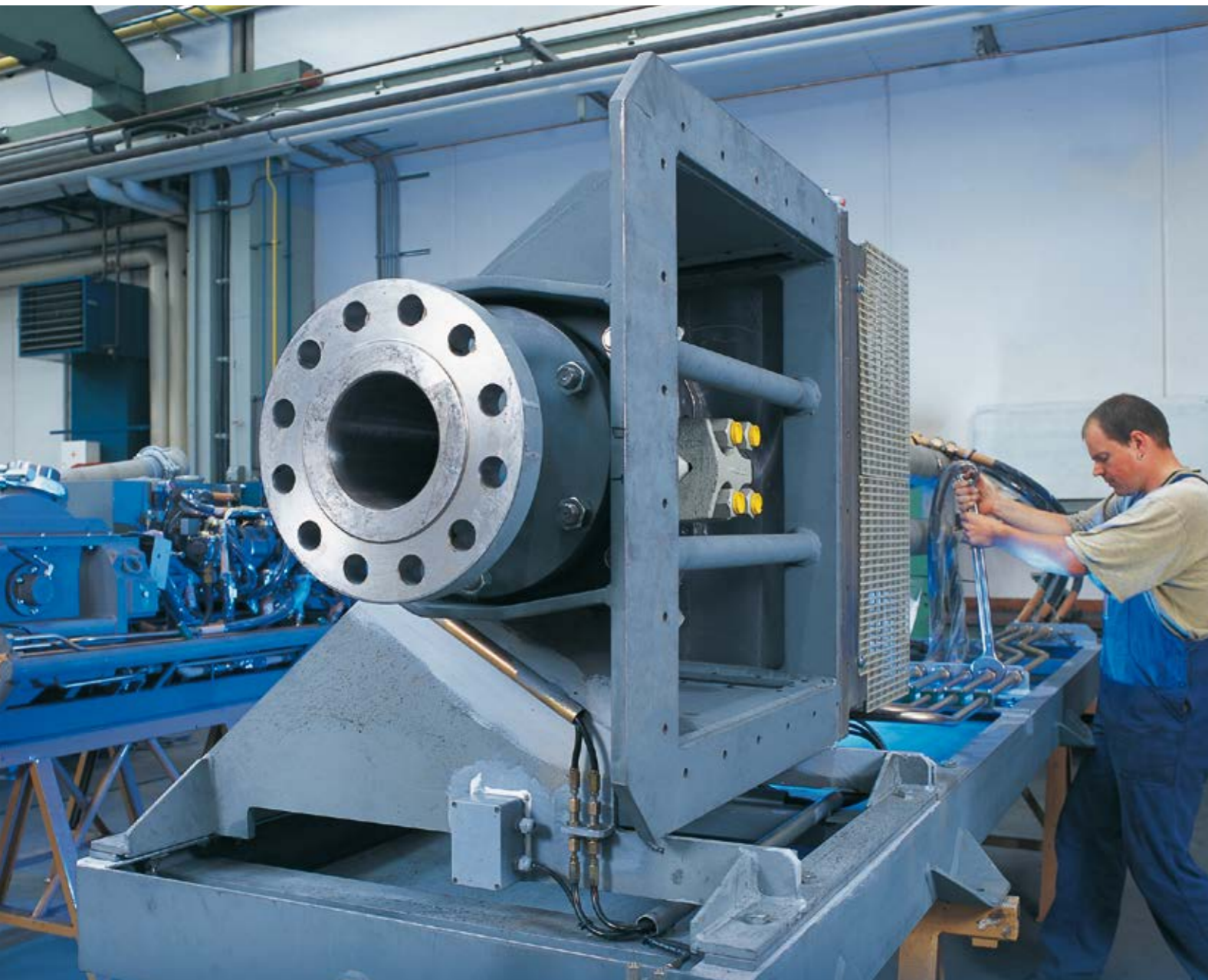

Supply of turnkey systems



Transparency and adherence to deadlines in project management

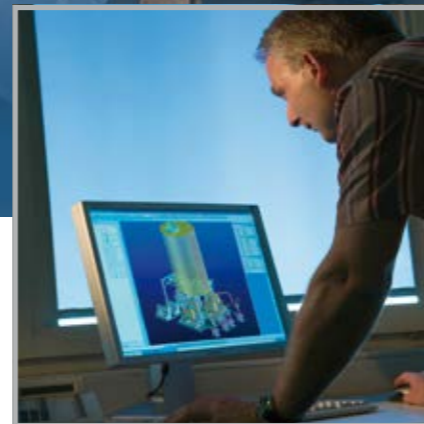

Increased safety and efficiency through modern design processes

Putzmeister supplies complete systems for the transportation and storage of sludges and solids. The scope of services includes the planning and engineering of conveying tasks, consultation services regarding the transportation's process engineering, the supply of pumps, silos, bunkers as well as pipes and fittings, installation and commissioning at customer site and also complete services after handover of the system.

System planning, development and control

Modern automation and visualization systems are used for controlling the plant unit. These systems control and monitor the plant from the reception of the sludge in the pump up to the metering of the sludge into the incineration furnace or the final place of use. The Finite Element Method is used in our design calculations and state-of-the-art CAD systems for realizing and implementing the designs. This ensures an effective and high-quality solution.

Knowledge Transfer

We offer plant-related in-house trainings as well as on-site seminars.

User-friendly documentation

Thanks to professional and comprehensive documentation, system operators can count on a simple operation of the plant and easy trouble-shooting.

Reliable service

A major factor of Putzmeister's services is an efficient and powerful sales management. In addition to a telephone hotline, we supply parts on short notice and also carry out maintenance works as part of a contract.



Technical training at customer premises



Rapid response assistance from Putzmeister's after-sales service

Plant delivery from a general contractor

- Highest level functional reliability
- Less time spent with order processing and interface co-ordination
- Perfect harmony between all functional units
- Less spare parts and storage requirements due to the use of versatile common parts in the system components
- Simplified servicing and maintenance thanks to standardized control and maintenance elements
- Clear assignment of responsibilities means rapid solutions to problems in the event of a malfunction

The plants supplied meet EU directives, also specific standards and certifications

- EC machinery directive
- EC Atex directive
- EC pressure equipment directive
- EG Low voltage directive
- DIN / EN / ISO
- UL / CSA / ANSI / ASME / API
- NORSOK / GOST / RTN
- Local regulations
- ISO 9001
- SCC

Innovations – made in Germany



Putzmeister headquarter in Aichtal



Putzmeister Solid Pumps GmbH

Max-Eyth-Straße 10 · 72631 Aichtal / Germany

P.O. Box 2152 · 72629 Aichtal / Germany

Tel. +49 (7127) 599-500 · Fax +49 (7127) 599-988

psp@pmw.de · www.pmsolid.com

